

CoaXPress Camera

Monochrome / Color CMOS 16M / 20M / 24.5M

High Speed Model

BC-SMS24M12X1H(Monochrome)

BC-SCS24M12X1H(Color)

BC-SMS20M12X1H(Monochrome)

BC-SCS20M12X1H(Color)

BC-SMS16M12X1H(Monochrome)

BC-SCS16M12X1H(Color)

Normal Speed Model

BC-SMS24M10X1N(Monochrome)

BC-SCS24M10X1N(Color)

BC-SMS20M10X1N(Monochrome)

BC-SCS20M10X1N(Color)


BC-SMS16M10X1N(Monochrome)

BC-SCS16M10X1N(Color)

Product Specifications

BOPIXEL JAPAN Co., Ltd.

Safety precautions

- This product is not designed and manufactured for applications that may cause damage to the human body, so do not use it for that purpose.
- This product is not waterproof. Do not use this product in an environment where it will be directly exposed to liquid or in a humid place.
- Do not use the camera in an environment with flammable liquids or gases. It may cause a fire or an explosion.
- In environments where the temperature changes drastically, use the camera and lens after taking measures to prevent condensation. Condensation inside the camera may cause a malfunction.
- Use the camera in the environment described in the specifications. It may cause malfunction or malfunction.
- The housing temperature is high while the camera is in use. In particular, the camera labeled  may have a housing temperature of more than 60°C depending on the environment in which it is used. Do not touch the camera during use or immediately after use. Doing so may cause burns or injuries.
- Use the supply voltage and the I/O signal to the camera within the range described in the specifications. It may cause malfunction or malfunction.
- When wiring to the camera connector, follow the pin assignments described in the specifications and be careful not to stress the wiring or camera connection. It may cause malfunction or malfunction.
- Do not disassemble the camera.

Precautions for use

- Do not subject the camera to shock or static electricity.
- When not using the camera, use a lens mount cap or protective sheet to prevent dust from adhering to the CMOS sensor imaging surface.
- Blow off any dirt on the glass surface with an air duster or similar tool, and be careful not to scratch the glass surface.
- If there is a noise source such as a motor near the camera or wiring cable, the image may be distorted or communication failure may occur. Keep the camera and wiring cables away from noise sources.
- Due to the inherent characteristics of CMOS sensors, pixel defects may occur during transportation and storage.

Table of Contents

1	SPECIFICATIONS	5
1.1	Electronic Specifications	5
1.2	Mechanical Specifications	9
1.3	Environmental Specifications	9
2	CMOS INFORMAITON	12
2.1	Relative respons	12
2.2	Color Filter Array	13
3	CAMERA HARDWARE INFORMATION	14
3.1	Interface	14
3.2	IO Connector	14
3.3	GPIO Line Circuit	15
3.3.1	Line0, Line1	15
4.	CAMERA DIMENSIONS	16
5	CAMERA OPERATION	17
5.1	GenICam Command Reference Table	17
5.1.1	Standard functions	17
5.1.2	Standard functions (Common to each model)	18
5.1.3	Original functions of BOPIXEL	20
6	IMAGE ACQUISITION AND CAMERA TRIGGER MODES	22
6.1	Trigger Source	22
6.1.1	Software	22
6.1.2	Line0-Line1	22
6.1.3	LinkTrigger	22
6.2	Trigger Acquisition Mode	23
6.2.1	Overlap Mode	23
6.2.2	Fast Trigger Mode	24
6.2.3	Horizontal Period by camera settings	25

6.2.4	Trigger prohibition period when changing settings	26
6.3	Exposure Mode	27
6.3.1	Exposure Mode : OFF(Free-Run)	27
6.3.2	Exposure Mode : Timed	27
6.3.3	Exposure Mode : Trigger Width	27
6.3.4	Trigger prohibition Time	28
6.3.5	Trigger LineDebounce Time	31
6.3.6	Minimum ExposureTime	32
7	FRAMERATE CALCURATE [FRAME RATE CALCULATION]	34
8	REVISION INFORMATION	35

1 Specifications

1.1 Electronic Specifications

□High Speed Model

Item		Specification	
Model Number		BC-SMS24M12X1H	BC-SCS24M12X1H
Image Sensor		Sony: IMX530AAMJ-C Monochrome CMOS	Sony: IMX530AAQJ-C Color CMOS
Shutter Type		Global	
Active Pixel		5312 (H) x 4608 (V): 24.5MPixel	
Pixel Size		2.74 (H) x 2.74 (V) μ m	
Maximum Frame Rate		CXP3_X1: 11.7 fps (CMOS8bit ,CXP8bit) / 11.7 fps (CMOS10bit ,CXP8bit) / 9.24 fps (CMOS10bit ,CXP10bit) CXP6_X1: 23.5 fps (CMOS8bit ,CXP8bit) / 23.5 fps (CMOS10bit ,CXP8bit) / 18.4 fps (CMOS10bit ,CXP10bit) CXP10_X1: 37.7 fps (CMOS8bit ,CXP8bit) / 37.7 fps (CMOS10bit ,CXP8bit) / 30.6 fps (CMOS10bit ,CXP10bit) CXP12_X1: 47.2 fps (CMOS8bit ,CXP8bit) / 47.2 fps (CMOS10bit ,CXP8bit) / 38.1 fps (CMOS10bit ,CXP10bit)	
Video Output Format		CXP12_X1, CXP10_X1, CXP6_X1, CXP3_X1	
Noise Leve (*1)		Less than 2.6 (@Gain 0 dB, CMOS10bits)	Less than 2.6 (@Gain 0 dB, CMOS10bits)
Sensitivity (*2)		240Lux(@CMOS8bit) /920Lux(@CMOS10bit)	480Lux (@CMOS8bit) / 1840Lux(@CMOS10bit)
ROI		Width (Horizontal): 16 to 5312 / Height (Vertical): 16 to 4608 Adjustable Steps for size: 16 pixels in width direction / 16 lines in height direction Adjustable Steps for offset: 16 pixels in width direction / 16 lines in height direction	
Power	Input Voltage	PoCXP or External 24V \pm 10%	
	Consumption	Typical: 4.25 W, Maximum: 4.35 W	

Item		Specification	
Model Number		BC-SMS20M12X1H	BC-SCS20M12X1H
Image Sensor		Sony: IMX531AAMJ-C Monochrome CMOS	Sony: IMX531AAQJ-C Color CMOS
Shutter Type		Global	
Active Pixel		4512 (H) x 4512 (V): 20.35MPixel	
Pixel Size		2.74 (H) x 2.74 (V) μ m	
Maximum Frame Rate		CXP3_X1: 14.1 fps (CMOS8bit ,CXP8bit) / 14.1 fps (CMOS10bit ,CXP8bit) /11.2 fps (CMOS10bit ,CXP10bit) CXP6_X1: 28.3 fps (CMOS8bit ,CXP8bit) / 28.3 fps (CMOS10bit ,CXP8bit) / 23.2 fps (CMOS10bit ,CXP10bit) CXP10_X1: 45.4 fps (CMOS8bit ,CXP8bit) / 45.4 fps (CMOS10bit ,CXP8bit) / 31.2 fps (CMOS10bit ,CXP10bit) CXP12_X1: 56.6 fps (CMOS8bit ,CXP8bit) / 56.6 fps (CMOS10bit ,CXP8bit) / 45.4 fps (CMOS10bit ,CXP10bit)	
Video Output Format		CXP12_X1, CXP10_X1, CXP6_X1, CXP3_X1	
Noise Leve (*1)		Less than 2.6 (@Gain 0 dB, CMOS10bits)	Less than 2.6 (@Gain 0 dB, CMOS10bits)
Sensitivity (*2)		240Lux(@CMOS8bit) /920Lux(@CMOS10bit)	480Lux (@CMOS8bit) / 1840Lux(@CMOS10bit)
ROI		Width (Horizontal): 16 to 4512 / Height (Vertical): 16 to 4512 Adjustable Steps for size: 16 pixels in width direction / 16 lines in height direction Adjustable Steps for offset: 16 pixels in width direction / 16 lines in height direction	
Power	Input Voltage	PoCXP or External 24V \pm 10%	
	Consumption	Typical: 4.25 W, Maximum: 4.35 W	

Item		Specification	
Model Number		BC-SMS16M12X1H	BC-SCS16M12X1H
Image Sensor		Sony: IMX532AAMJ-C Monochrome CMOS	Sony: IMX532AAQJ-C Color CMOS
Shutter Type		Global	
Active Pixel		5312 (H) x 3040 (V): 16.19MPixel	
Pixel Size		2.74 (H) x 2.74 (V) μ m	
Maximum Frame Rate		CXP3_X1: 17.5 fps (CMOS8bit ,CXP8bit) / 17.5 fps (CMOS10bit ,CXP8bit) /13.7 fps (CMOS10bit ,CXP10bit) CXP6_X1:35.0 fps (CMOS8bit ,CXP8bit) / 35.0 fps (CMOS10bit ,CXP8bit) / 27.4 fps (CMOS10bit ,CXP10bit) CXP10_X1: 56.1 fps (CMOS8bit ,CXP8bit) / 56.1 fps (CMOS10bit ,CXP8bit) / 45.5 fps (CMOS10bit ,CXP10bit) CXP12_X1: 70.2 fps (CMOS8bit ,CXP8bit) / 70.2 fps (CMOS10bit ,CXP8bit) / 56.7 fps (CMOS10bit ,CXP10bit)	
Video Output Format		CXP12_X1, CXP10_X1, CXP6_X1, CXP3_X1	
Noise Leve (*1)		Less than 2.6 (@Gain 0 dB, CMOS10bits)	Less than 2.6 (@Gain 0 dB, CMOS10bits)
Sensitivity (*2)		240Lux(@CMOS8bit) /920Lux(@CMOS10bit)	480Lux (@CMOS8bit) / 1840Lux(@CMOS10bit)
ROI		Width (Horizontal): 16 to 5312 / Height (Vertical): 16 to3040 Adjustable Steps for size: 16 pixels in width direction / 16 lines in height direction Adjustable Steps for offset: 16 pixels in width direction / 16 lines in height direction	
Power	Input Voltage	PoCXP or External 24V \pm 10%	
	Consumption	Typical: 4.25 W, Maximum: 4.35 W	

 Normal Speed Model

Item		Specification	
Model Number		BC-SMS24M10X1N	BC-SCS24M10X1N
Image Sensor		Sony: IMX540AAMJ-C Monochrome CMOS	Sony: IMX540AAQJ-C Color CMOS
Shutter Type		Global	
Active Pixel		5312 (H) x 4608 (V): 24.5MPixel	
Pixel Size		2.74 (H) x 2.74 (V) μ m	
Maximum Frame Rate		CXP3_X1: 11.7 fps (CMOS8bit ,CXP8bit) / 11.7 fps (CMOS10bit ,CXP8bit) / 9.24 fps (CMOS10bit ,CXP10bit) CXP6_X1: 23.5 fps (CMOS8bit ,CXP8bit) / 23.5 fps (CMOS10bit ,CXP8bit) / 18.4 fps (CMOS10bit ,CXP10bit) CXP10_X1: 34.6 fps (CMOS8bit ,CXP8bit) / 28.2 fps (CMOS10bit ,CXP8bit) / 28.2 fps (CMOS10bit ,CXP10bit)	
Video Output Format		CXP10_X1, CXP6_X1, CXP3_X1	
Noise Leve (*1)		Less than 2.6 (@Gain 0 dB, CMOS10bits)	Less than 2.6 (@Gain 0 dB, CMOS10bits)
Sensitivity (*2)		240Lux(@CMOS8bit) /920Lux(@CMOS10bit)	480Lux (@CMOS8bit) / 1840Lux(@CMOS10bit)
ROI		Width (Horizontal): 16 to 5312 / Height (Vertical): 16 to 4608 Adjustable Steps for size: 16 pixels in width direction / 16 lines in height direction Adjustable Steps for offset: 16 pixels in width direction / 16 lines in height direction	
Power	Input Voltage	PoCXP or External 24V \pm 10%	
	Consumption	Typical: 3.4 W, Maximum: 3.45 W	

Item		Specification	
Model Number		BC-SMS20M10X1N	BC-SCS20M10X1N
Image Sensor		Sony: IMX541AAMJ-C Monochrome CMOS	Sony: IMX541AAQJ-C Color CMOS
Shutter Type		Global	
Active Pixel		4512 (H) x 4512 (V): 20.35MPixel	
Pixel Size		2.74 (H) x 2.74 (V) μ m	
Maximum Frame Rate		CXP3_X1: 14.1 fps (CMOS8bit ,CXP8bit) / 14.1 fps (CMOS10bit ,CXP8bit) /11.5 fps (CMOS10bit ,CXP10bit) CXP6_X1: 28.3 fps (CMOS8bit ,CXP8bit) / 28.3 fps (CMOS10bit ,CXP8bit) / 23.0 fps (CMOS10bit ,CXP10bit) CXP10_X1: 42.1 fps (CMOS8bit ,CXP8bit) / 33.7 fps (CMOS10bit ,CXP8bit) / 33.7 fps (CMOS10bit ,CXP10bit)	
Video Output Format		CXP10_X1, CXP6_X1, CXP3_X1	
Noise Leve (*1)		Less than 2.6 (@Gain 0 dB, CMOS10bits)	Less than 2.6 (@Gain 0 dB, CMOS10bits)
Sensitivity (*2)		240Lux(@CMOS8bit) /920Lux(@CMOS10bit)	480Lux (@CMOS8bit) / 1840Lux(@CMOS10bit)
ROI		Width (Horizontal): 16 to 4512 / Height (Vertical): 16 to 4512 Adjustable Steps for size: 16 pixels in width direction / 16 lines in height direction Adjustable Steps for offset: 16 pixels in width direction / 16 lines in height direction	
Power	Input Voltage	PoCXP or External 24V \pm 10%	
	Consumption	Typical: 3.4 W, Maximum: 3.45 W	

Item		Specification	
Model Number		BC-SMS16M10X1N	BC-SCS16M10X1N
Image Sensor		Sony: IMX542AAMJ-C Monochrome CMOS	Sony: IMX542AAQJ-C Color CMOS
Shutter Type		Global	
Active Pixel		5312 (H) x 3040 (V): 16.19MPixel	
Pixel Size		2.74 (H) x 2.74 (V) μ m	
Maximum Frame Rate		CXP3_X1: 17.5 fps (CMOS8bit ,CXP8bit) / 17.5 fps (CMOS10bit ,CXP8bit) /13.7 fps (CMOS10bit ,CXP10bit) CXP6_X1:35.0 fps (CMOS8bit ,CXP8bit) / 35.0 fps (CMOS10bit ,CXP8bit) / 27.4 fps (CMOS10bit ,CXP10bit) CXP10_X1: 51.5 fps (CMOS8bit ,CXP8bit) / 41.9 fps (CMOS10bit ,CXP8bit) / 41.9 fps (CMOS10bit ,CXP10bit)	
Video Output Format		CXP10_X1, CXP6_X1, CXP3_X1	
Noise Leve (*1)		Less than 2.6 (@Gain 0 dB, CMOS10bits)	Less than 2.6 (@Gain 0 dB, CMOS10bits)
Sensitivity (*2)		240Lux(@CMOS8bit) /920Lux(@CMOS10bit)	480Lux (@CMOS8bit) / 1840Lux(@CMOS10bit)
ROI		Width (Horizontal): 16 to 5312 / Height (Vertical): 16 to3040 Adjustable Steps for size: 16 pixels in width direction / 16 lines in height direction Adjustable Steps for offset: 16 pixels in width direction / 16 lines in height direction	
Power	Input Voltage	PoCXP or External 24V \pm 10%	
	Consumption	Typical: 3.4 W, Maximum: 3.45 W	

*1 The noise level is measured under the measurement conditions of gain: 0 dB, 200 [DN].

*2 Sensitivity is measured under the following measurement conditions.

Lens:F5.6, Gain:0dB, ExposureTime:1/30sec, Light Source: light Box(5100K)

Item		Specification	
Sync System		Free run / External trigger (Hardware / Software) / LinkTrigger (use of coax cable)	
Video Format		8 bits (Mono8) / 10bit (Mono10)	8 bit (BayerRG8) / 10 bit (BayerRG10)
Exposure time(*1)		Minimum ExposureTime to 16.777 seconds	
Gain	Analog Gain	0 to 18dB	
	Digital Gain	0 to 24dB	
Black Level		0 to 80 DN 8bit	
White Balance Gain		N/A	Formula1: 1 to 5 Times Formula2: 1 to 8 Times
Image Flip		Reverse X / Reverse Y (Default: OFF)	
Sharding Correction		Support	
Bining		2x2 binning	N/A
Decimation		Decimation (V/H 1/2subsampling)	
Pixel Defect Correction		Up to 1024 points	
Operational Mode		Free-run (Trigger Mode: Off) / Edge-preset Trigger (Trigger Mode: On, Exposure Mode: Timed) / Pulse width Trigger (Trigger Mode: On, Exposure Mode: Trigger Width)	
User Setting Storage		Support	
Communication		CoaXPress Standard Ver1.1	
Protocol		GenICam Standard Version (SFNC 2.5) compliant	
Input / Output		GPIO x 2	

Common specifications for each model

*1 Refer to [Minimum ExposureTime].

1.2 Mechanical Specifications

Item	Specification
Dimensions	29 (W) x 29 (H) x 39.5 (D) mm (*1)
Material	Aluminum alloy
Lens Mount	C Mount
Interface Connectors	Micro-BNC Connector /O Connector: HR10A-7R-6PB (Hirose) or equivalent
Camera Mounting	M3 screws holes (Two on top, Three on bottom)
Weight	Approximately 54 g

(*1) excluding the connectors

1.3 Environmental Specifications

Item	Specification
Operational Temperature / Humidity	Device Temperature (Camera internal temperature sensor) : 0 to 70 deg C (*1) Camera housing temperature when Device Temp is 70 deg C : 66 deg C (*1) Figure 1.3-1 shows the measurement points of the camera housing temperature. (Reference) The ambient temperature when Device Temp. reaches 70 deg C varies depending on the size of the attached lens and the camera installation conditions. Figures 1.3-2 and 1.3-3 show the relationship between the lens size and the usable environmental temperature when the camera is installed under the worst conditions (*2). Environmental Humidity : 0 to 85%RH (No condensation)
Storage Temperature / Humidity	Environmental Temperature: -25 to +70 °C Environmental Humidity: 0 to 85%RH (No condensation)
Vibration	20 Hz to 200 Hz to 20 Hz (5 min. / cycle), acceleration 10 G, XYZ 3 directions 30 min. each
Shock	Acceleration 38 G, half amplitude 6ms, XYZ 3 directions 3 times each
Standard Compliancy	EMI: EN55032:2015+A11:2020, EN61000-3-2:2019, EN61000-3-3:2013+A1:2019 EMS: EN55035:2017+A11:2020 LVD: EN62368-1:2014+A11:2017
RoHS	RoHS Compliant

(*1) Use in an installation environment where the [Device Temperature] (Camera internal temperature sensor) read by communication is 70 deg C or less.

Alternatively, use it in an installation environment where the camera housing temperature is 66 deg C or lower.

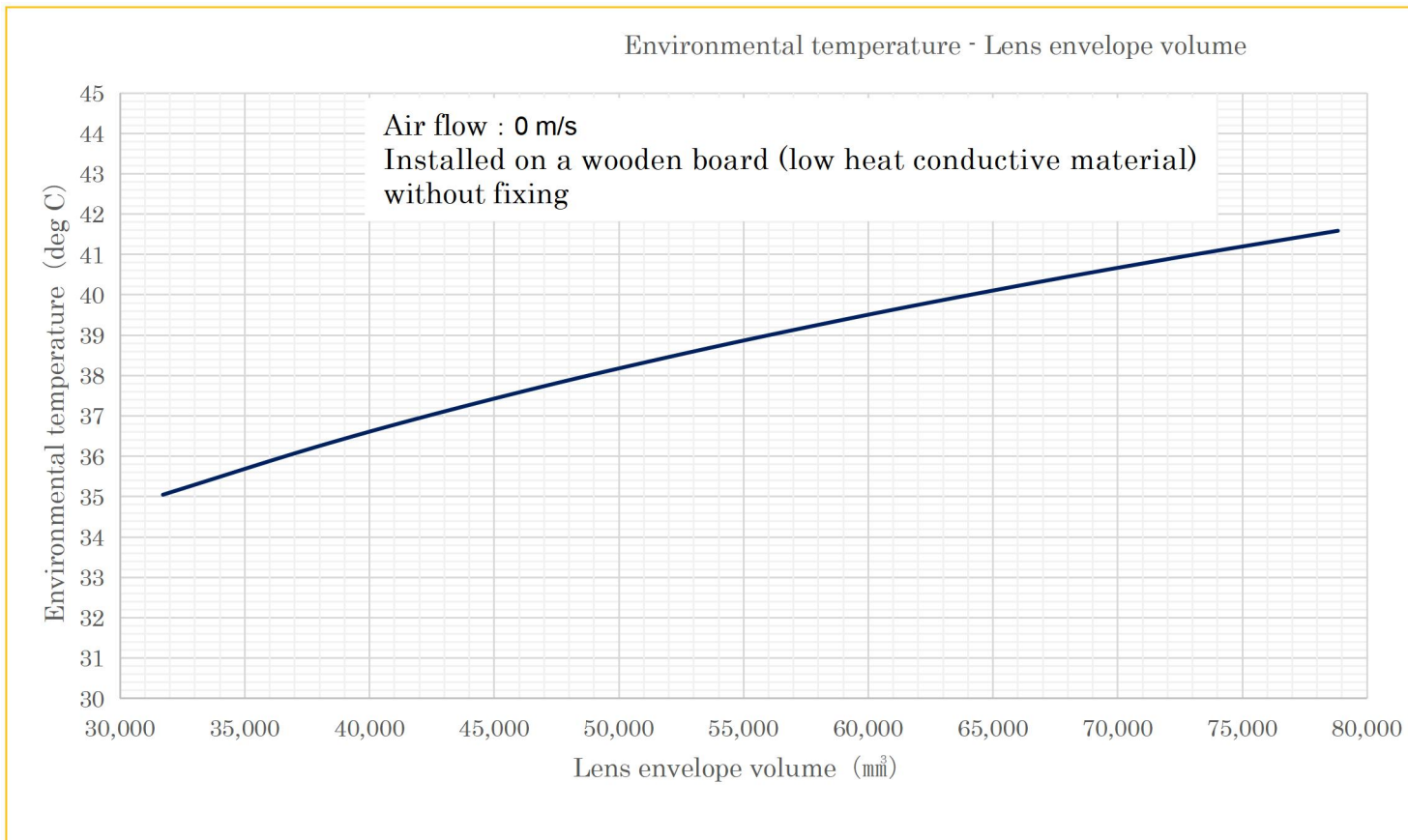
(*2) The worst condition for camera installation is that there is no heat dissipation from the camera housing to the structure that is naturally air-cooled (no wind) and fixes the camera. ➔ Airflow : 0 m/s, Installed on a low thermal conductive material such as wood board without fixing

The usable environment temperature can be raised by improving the camera installation (fixing method that can dissipate heat from the camera housing, increasing the air flow around the camera, etc.).

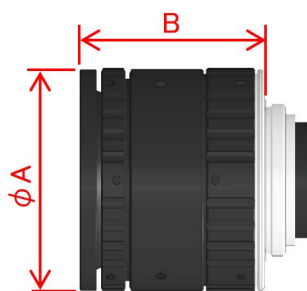


Fig1.3-1 Camera housing measuring point

BC-SMS16M12X1H、BC-SMS20M12X1H、BC-SMS24M12X1H、BC-SCS16M12X1H、BC-SCS20M12X1H、BC-SCS24M12X1H



(Reference) Fig1.3-2 Relationship between attached lens size and usable environmental temperature
 (Camera installation : Worst condition、 Device Temp.=70 deg C)



$$\text{Lens envelope volume (mm}^3\text{)} = (\phi A/2)^2 \times \pi \times B$$

(Example) Lens envelope volume=64,000 mm³

➔Usable environmental temperature : 0~40 deg C

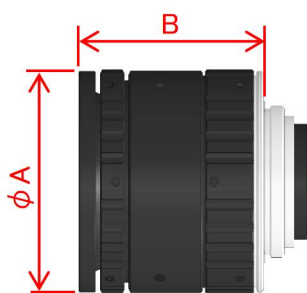
※The usable environmental temperature can be raised depending on the material and size of the member that fixes the camera and the air flow condition around the camera.

Check the usable environmental temperature with Device Temp. And camera housing temperature.

BC-SMS16M10X1N、BC-SMS20M10X1N、BC-SMS24M10X1N、BC-SCS16M10X1N、BC-SCS20M10X1N、BC-SCS24M10X1N



(Reference) Fig1.3-3 Relationship between attached lens size and usable environmental temperature
 (Camera installation : Worst condition、 Device Temp.=70 deg C)



$$\text{Lens envelope volume (mm}^3\text{)} = (\phi A/2)^2 \times \pi \times B$$

(Example) Lens envelope volume=45,000 mm³

➔ Usable environmental temperature : 0~42 deg C

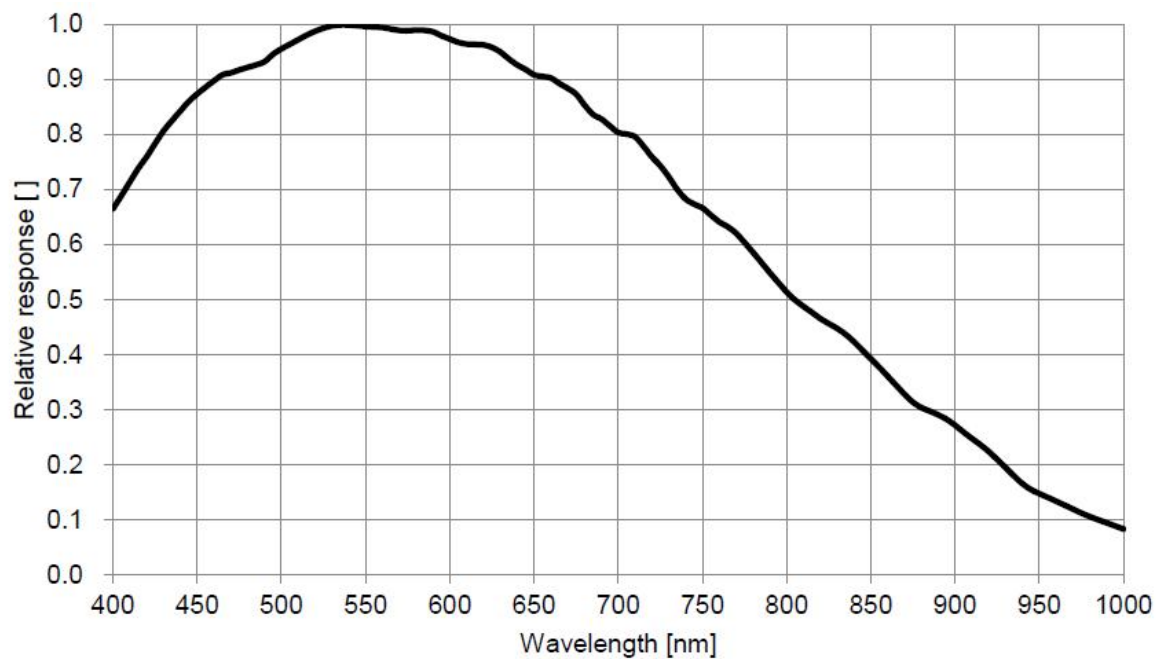
※The usable environmental temperature can be raised depending on the material and size of the member that fixes the camera and the air flow condition around the camera.

Check the usable environmental temperature with Device Temp. And camera housing temperature.

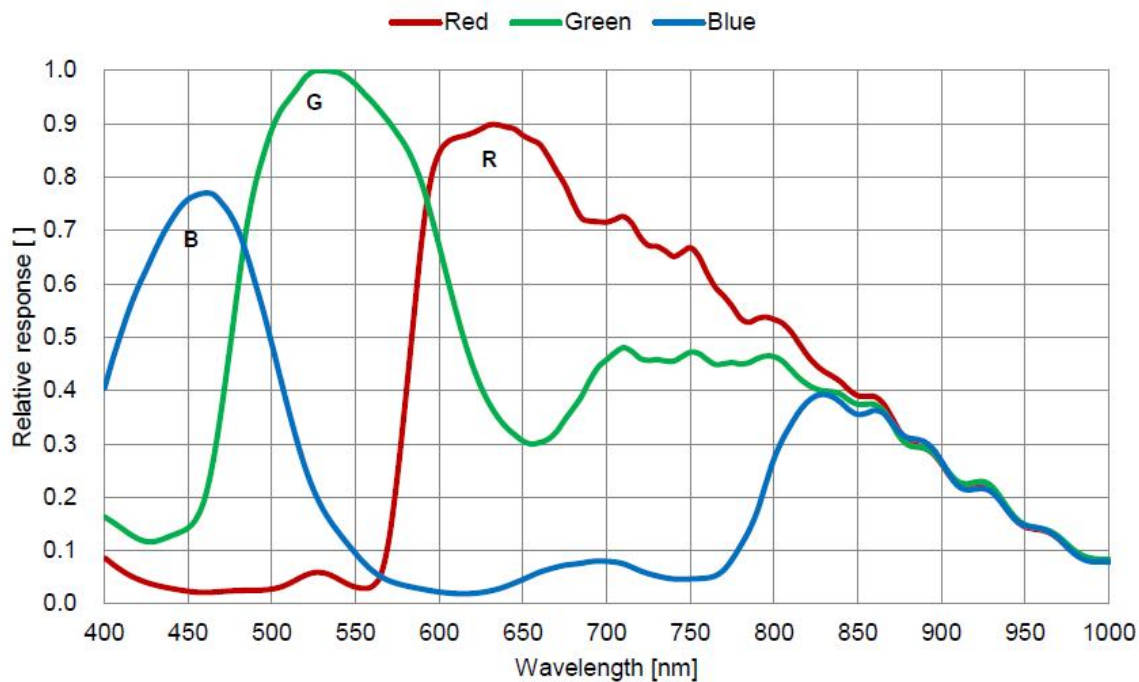
2 CMOS Informaiton

2.1 Relative respons

Mono Model



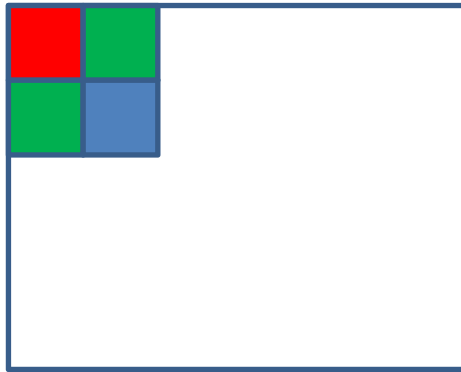
Color Model



2.2 Color Filter Array

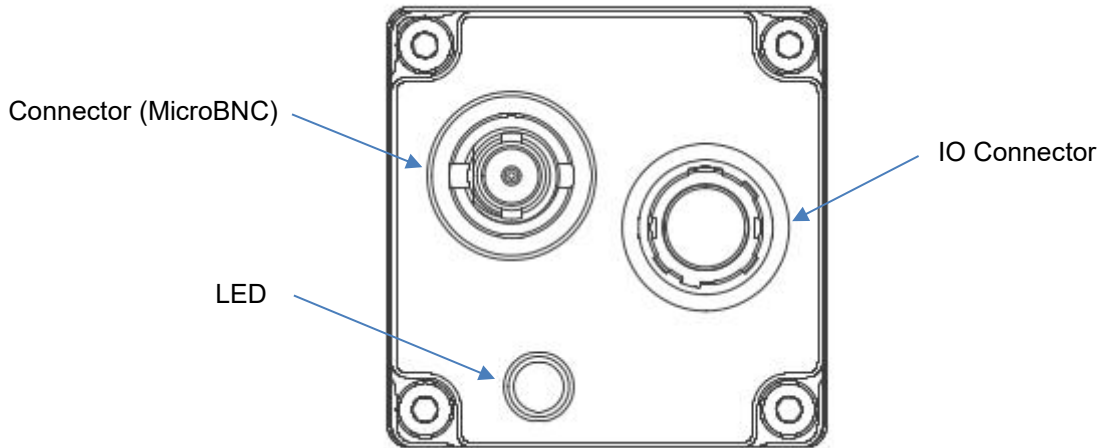
Color Model

(0,0)



3 Camera Hardware Information

3.1 Interface



3.2 IO Connector

- HR10A-7P-6S (Hirose) or equivalent can be used.
- GPIO can select input and output by camera setting.

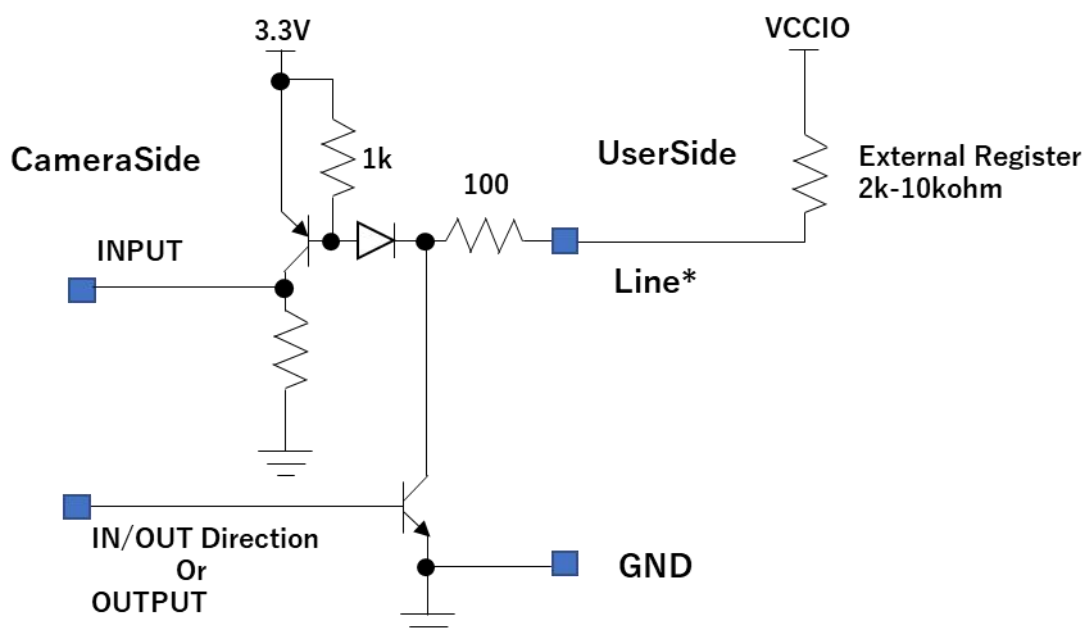
Pin assignment And DC characteristics



Pin No.	Signal Name	Function	DIR	電圧	
				Low Voltage	High Voltage
1	DC24V	POWER	IN	DC24V±10%	
2	Line0	GPIO	IN	Less than+1.0V	+3.0 to +26.4V
			OUT	0 to +2.20V	+3.0 to +26.4V
3	Line1	GPIO	IN	Less than+1.0V	+3.0 to +26.4V
			OUT	0 to +2.20V	+3.0 to +26.4V
4	NC	NC	-	-	-
5	NC	NC	-	-	-
6	GND	GND	-	-	-

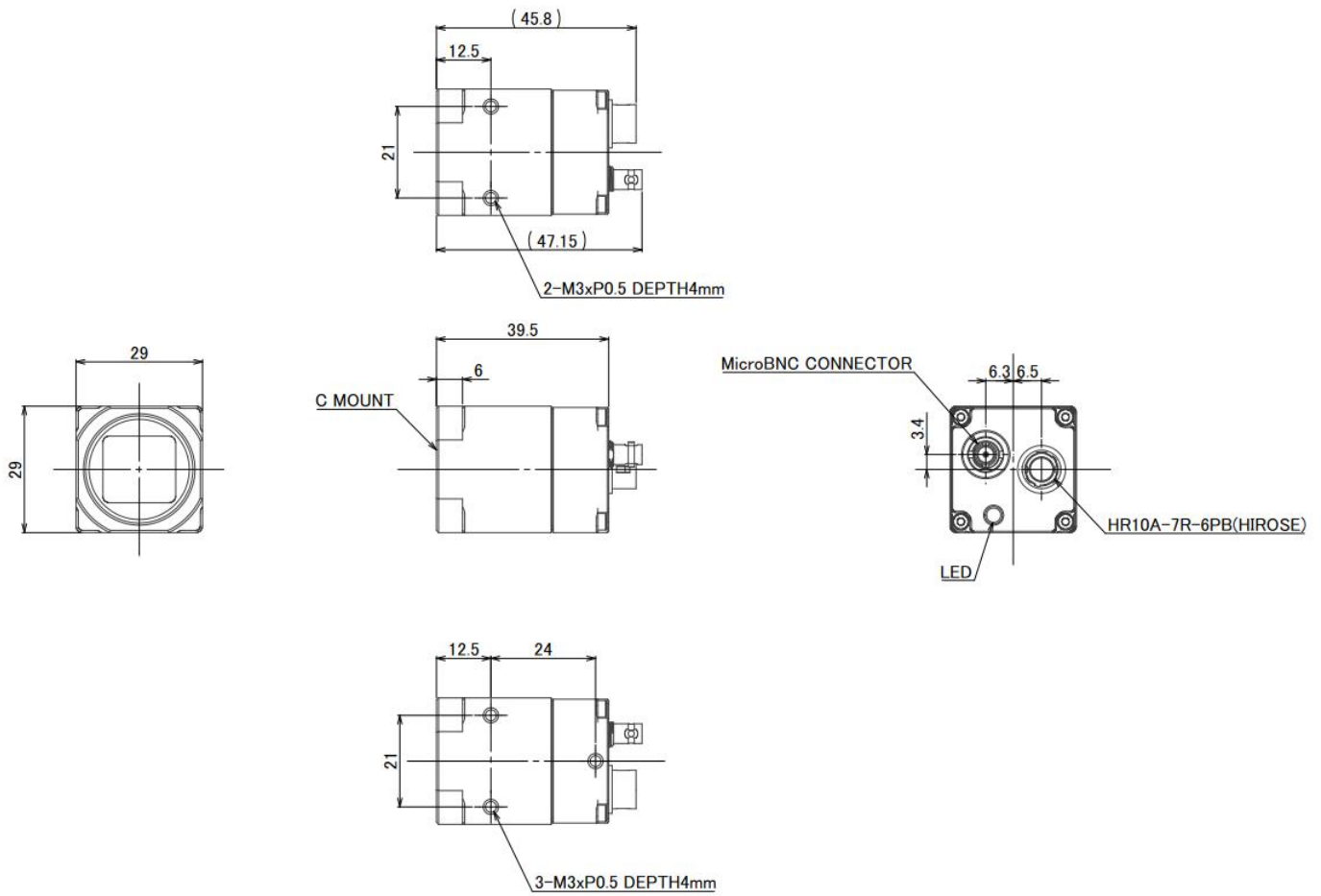
3.3 GPIO Line Circuit

3.3.1 Line0, Line1



4. Camera Dimensions

Unit: mm



5 Camera Operation

5.1 GenICam Command Reference Table

The setting items of the camera conform to SNFC of GenICam Standard Version.

The items implemented in the camera are as follows.

Please refer to SNFC of GenICam for details of the function except the original functions of BOPIXEL.

5.1.1 Standard functions

High Speed Model

GenICam command	Default		
	BC-SMS24M12X1H BC-SCS24M12X1H	BC-SMS20M12X1H BC-SCS20M12X1H	BC-SMS16M12X1H BC-SCS16M12X1H
DeviceModelName			
SensorWidth	5312	4512	5312
SensorHeight	4608	4512	3040
WidthMax	5312	4512	5312
HeightMax	4608	4512	3040
Width	5312	4512	5312
Height	4608	4512	3040
PayLoadSize	24477696	20358144	16148480

Normal Speed Model

GenICam command	Default		
	BC-SMS24M10X1N BC-SCS24M10X1N	BC-SMS20M10X1N BC-SCS20M10X1N	BC-SMS16M10X1N BC-SCS16M10X1N
DeviceModelName			
SensorWidth	5312	4512	5312
SensorHeight	4608	4512	3040
WidthMax	5312	4512	5312
HeightMax	4608	4512	3040
Width	5312	4512	5312
Height	4608	4512	3040
PayLoadSize	24477696	20358144	16148480

5.1.2 Standard functions (Common to each model)

GenICam command	Default
DeviceVendorName	BOPIXEL
DeviceManufacturerInfo	www.BOPIXELjapan.com
DeviceVersion	-
DeviceSerialNumber	-
DeviceUserID	00000000
DeviceTemperature	-
DeviceClockFrequency	74250000
OffsetX	0
OffsetY	0
ReverseX	False
ReverseY	False
PixelFormat	MonochromeModel: Mono8 / ColorMode : BayerRG8
TestPatternGeneratorSelector	FPGA
TestPattern	Off
BinningVerticalMode	Sum
BinningVertical	1
DecimationVerticalMode	Discard
DecimationVertical	1
AcquisitionFrameRate	Refer to [FrameRate calculate]
TriggerMode	Off
TriggerSource	Software
TriggerSoftware	-
TriggerDelay	0
ExposureMode	Off
ExposureTime	-
GainSelector	AnalogAll
Gain[AnalogAll] (*1)	0
Gain[DigitalAll] (*1)	0
BlackLevelSelector	All

GenICam command	Default
BlackLevel	10
BalanceRatioSelector	0 (ColorMode Only)
BalanceRatio[Red]	0 (ColorMode Only)
BalanceRatio[GreenR]	0 (ColorMode Only)
BalanceRatio[GreenB]	0 (ColorMode Only)
BalanceRatio[Blue]	0 (ColorMode Only)
WhiteBalanceFunctionMode(*2)	Formula1
LineSelector	Line0
LineMode	Input
LineInverter	False
LineStatus	-
LineSource	UserOutput0
UseroutputSelector	UserOutput0
UserOutputValue	False
	-
DeviceTapGeometry	Geometry_1X_1Y
CxpLinkConfigurationStatus	-
CxpLinkConfiguration	CXP6_X1
CxpLinkConfigurationPreferred	CXP6_X1
TestMode	Off
TestErrorCountSelector	0
TestErrorCount	0
UserSetSelector	Default
UserSetLoad	-
UserSetSave	-
UserSetDefault	Default

5.1.3 Original functions of BOPIXEL

GenICam command	Discription	Default
ImageSensorBitSize	Select the ADC bit size of the CMOS sensor. When set to CIS_8Bit, the image will be the image with the CMOS gain multiplied by 4.	CIS_10Bit
TriggerAcquisitionModeSelector	Selects the trigger acquisition mode. (Overlap / Fast) Refer to [TriggerAcquisitionMode]	Overlap
HorizontalPeriodExtend(*3)	Control the streaming throughput delay by extending the horizontal period.	0
EnablePixelCorrection	When set to ON, Activates pixel correction.	True
PixelCorrectionHighlight	When set to ON, the pixel of the coordinate to be corrected is highlighted.	False
PixelCorrectionIndex	Index for Pixel Correction Data.This can be set for 1024 points.	0
PixelCorrectionX	Set the X position. The pixel to be corrected is written at the factory. Users can be added.	65535
PixelCorrectionY	Set the Y position. The pixel to be corrected is written at the factory. Users can be added.	65535
LineDebounceTime	Specifies the delay in microseconds (us) to apply after receiving IO[Line*] signal and before activating it.	1
Enable Shading Correction	When set to True, Activates shading correction.	False
Shading Gain Selector	Select the gain color , Users want to change.	MonochromeModel: Mono ColorModel: Red/GreenR/GreenB/Blue
Shading Gain Manual[Mono]	Set the Shading gain. If maxGain and PosX/Y=1/2Width&HeightMax, The edge pixels have 2 times the gain of the center PosX/Y pixel. If 1/2maxGain and PosX/Y=1/2Width&HeightMax, The edge pixels have 1.5 times the gain of the center PosX/Y pixel.	0(MonochromeModel Only)
Shading Gain Manual [Red]		0 (ColorMode Only)
Shading Gain Manual [GreenR]		0 (ColorMode Only)
Shading Gain Manual [GreenB]		0 (ColorMode Only)
Shading Gain Manual [Blue]		0 (ColorMode Only)
Shading Center PosX Manual		0
Shading Center PosY Manual		0

(*1)Gain : $\text{AnalogAllGain} / 10 + \text{DigitalGainAll} / 10$ [dB]

(*2)White Balance Function Mode:

1) Formula1: $\text{OutValue} = \text{InValue} + (\text{InValue} - \text{BlackLevel}) * \text{BalanceRatio} / 64$ (Set 0 for 0dBGain)

2) Formula2: $\text{OutValue} = (\text{InValue} - \text{BlackLevel}) * \text{BalanceRatio} / 2048 + \text{BlackLevel}$ (Set 2048 for 0dBGain)

(*3) HorizontalPeriodExtend

It is a function that control the streaming throughput delay by extending the horizontal period.

Set the value when using a grabber board with a small StreamPacketSizeMax.

6 Image Acquisition and Camera Trigger Modes

TriggerMode : By setting it to ON, the user can input a trigger to the camera from the outside.

TriggerMode : When set to OFF, a trigger is generated inside the camera at the cycle of AcquisitionFrameRate.

TriggerMode : If OFF, the Trigger Acquisition Mode setting works in Overlap Mode.

6.1 Trigger Source

6.1.1 Software

A trigger is input by a communication command from the camera.

When software trigger is used, the timing of trigger input to the camera may not be guaranteed because it depends on the operating status of the host PC.

6.1.2 Line0-Line1

A trigger is input from the 6-pin connector (GPIO) of the camera.

When using the Line trigger, it is necessary to keep the voltage input range to the IO pin.

6.1.3 LinkTrigger

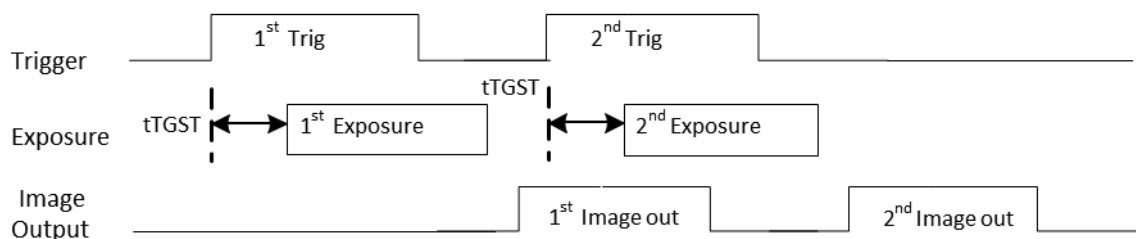
A trigger is input from the Cable line of the grabber board.

The trigger input method from LinkTrigger depends on the grabber board specifications.

6.2 Trigger Acquisition Mode

6.2.1 Overlap Mode

In this mode, Next trigger can be input during the sensor image read out.
 However, exposure start timing is delayed and 1 jitter horizontal period sensor drive term.
 The exposure start timing and exposure start time after the trigger input are shown below.



Overlap timing image

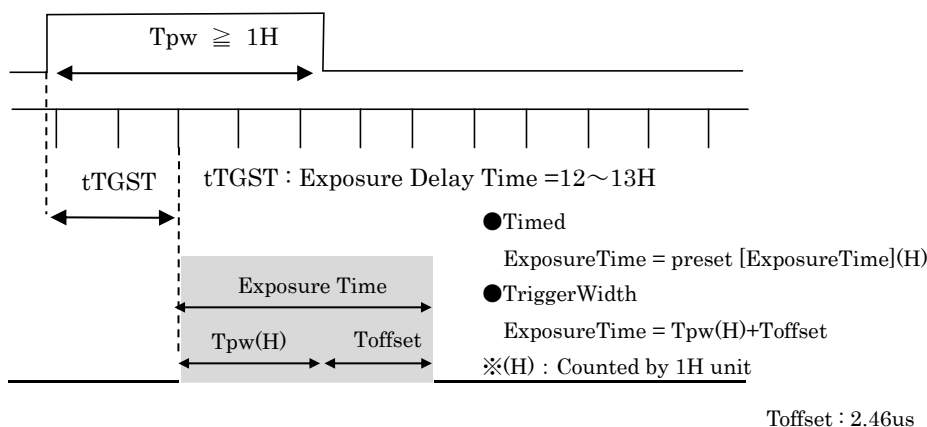
□ Exposure start timing

High Speed Model	Symbol	Min	Max	Unit
BC-SMS24M12X1H / BC-SCS24M12X1H	tTGST	12	13	Horizontal
BC-SMS20M12X1H / BC-SCS20M12X1H	tTGST	16	17	Horizontal
BC-SMS16M12X1H / BC-SCS16M12X1H	tTGST	12	13	Horizontal

Normal Speed Model	Symbol	Min	Max	Unit
BC-SMS24M10X1N / BC-SCS24M10X1N	tTGST	8	9	Horizontal
BC-SMS20M10X1N / BC-SCS20M10X1N	tTGST	8	9	Horizontal
BC-SMS16M10X1N / BC-SCS16M10X1N	tTGST	8	9	Horizontal

● The Detail Timing

a) Exposure Time > 1Horizontal Period



Exposure Time is counted by 1 Horizontal Period inside CMOS.
 When used with TriggerWidth, Toffset(2.46us) is added inside the CMOS.

$$\text{ExposureTime} = \text{Tp}_w + \text{Toffset}$$

※Horizontal Period depends on camera settings.

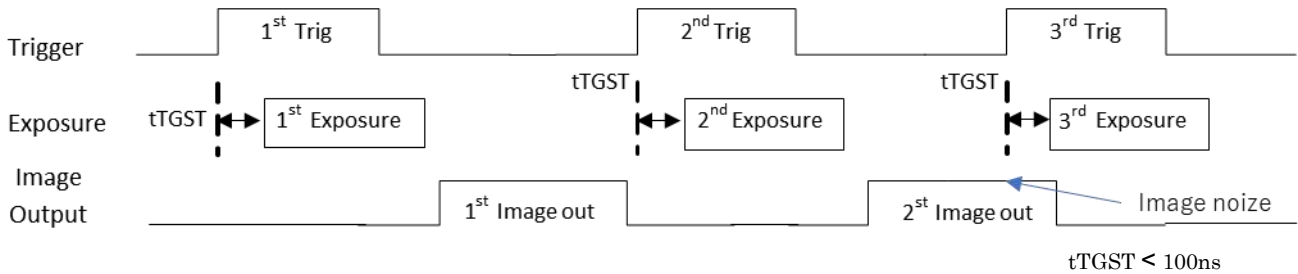
6.2.3 Refer to [Horizontal Period by Camera Settings].

ExposureTime has a lower limit that can be set: Minimum ExposureTime.

6.3.6 Refer to [Minimum ExposureTime]

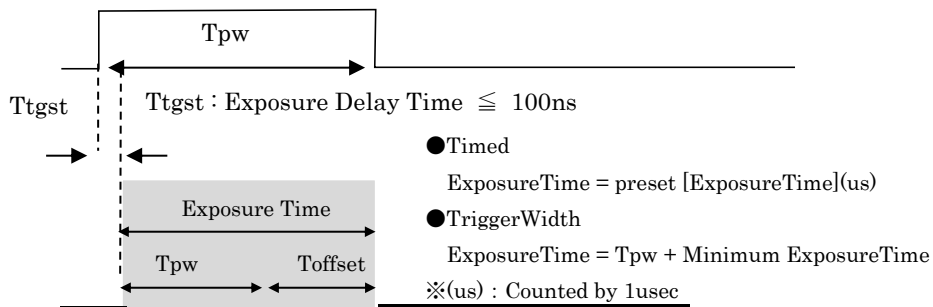
6.2.2 Fast Trigger Mode

In this mode, exposure starts immediately (delayed < 100nsec.) against the trigger signal input without the jitter. However, when the next trigger is input during the sensor image read out, some noise may be appeared with trigger input timing.



Fast Trigger timing image

- The Detail Timing



When used with TriggerWidth, Minimum ExposureTime is added inside the CMOS.

$$\text{ExposureTime} = \text{Tp}_w + \text{Minimum ExposureTime}$$

※Horizontal Period depends on camera settings.

6.2.3 Refer to [Horizontal Period by Camera Settings].

ExposureTime has a lower limit that can be set: Minimum ExposureTime.

6.3.6 Refer to [Minimum ExposureTime]

6.2.3 Horizontal Period by camera settings

The Horizontal Period depends on the CXP Link Configuration as shown in the table below.

If HorizontalPeriodExtend (default: 0) is set, the Horizontal Period is calculated by the following formula.

$$\text{Horizontal Period} = (\text{PARAM_H} + \text{HorizontalPeriodExtend}) / 74250000 \text{ [sec]}$$

□High Speed Model

Model	CXP Link Configuration		CIS Bit Size	Horizontal Period[usec] (default)	PARAM_H
BC-SMS24M12X1H BC-SCS24M12X1H	CXP3-1	Mono8/BayerRG8	CIS_8Bit	17.6969	1314
		Mono10/BayerRG10	CIS_10Bit	22.5723	1676
		Mono8/BayerRG8	CIS_10Bit	17.6969	1314
	CXP6-1	Mono8/BayerRG8	CIS_8Bit	8.8484	657
		Mono10/BayerRG10	CIS_10Bit	11.2862	838
		Mono8/BayerRG8	CIS_10Bit	8.8484	657
	CXP10-1	Mono8/BayerRG8	CIS_8Bit	5.5218	410
		Mono10/BayerRG10	CIS_10Bit	6.8148	506
		Mono8/BayerRG8	CIS_10Bit	5.5218	410
	CXP12-1	Mono8/BayerRG8	CIS_8Bit	4.4175	328
		Mono10/BayerRG10	CIS_10Bit	5.4680	406
		Mono8/BayerRG8	CIS_10Bit	4.4175	328
BC-SMS20M12X1H BC-SCS20M12X1H	CXP3-1	Mono8/BayerRG8	CIS_8Bit	15.0303	1116
		Mono10/BayerRG10	CIS_10Bit	18.3973	1366
		Mono8/BayerRG8	CIS_10Bit	15.0303	1116
	CXP6-1	Mono8/BayerRG8	CIS_8Bit	7.5151	558
		Mono10/BayerRG10	CIS_10Bit	9.2390	686
		Mono8/BayerRG8	CIS_10Bit	7.5151	558
	CXP10-1	Mono8/BayerRG8	CIS_8Bit	4.6868	348
		Mono10/BayerRG10	CIS_10Bit	5.8148	432
		Mono8/BayerRG8	CIS_10Bit	4.6868	348
	CXP12-1	Mono8/BayerRG8	CIS_8Bit	3.7575	279
		Mono10/BayerRG10	CIS_10Bit	4.6599	346
		Mono8/BayerRG8	CIS_10Bit	3.7575	279
BC-SMS16M12X1H BC-SCS16M12X1H	CXP3-1	Mono8/BayerRG8	CIS_8Bit	17.6969	1314
		Mono10/BayerRG10	CIS_10Bit	22.5723	1676
		Mono8/BayerRG8	CIS_10Bit	17.6969	1314
	CXP6-1	Mono8/BayerRG8	CIS_8Bit	8.8484	657
		Mono10/BayerRG10	CIS_10Bit	11.2862	838
		Mono8/BayerRG8	CIS_10Bit	8.8484	657
	CXP10-1	Mono8/BayerRG8	CIS_8Bit	5.5218	410
		Mono10/BayerRG10	CIS_10Bit	6.8148	506
		Mono8/BayerRG8	CIS_10Bit	5.5218	410
	CXP12-1	Mono8/BayerRG8	CIS_8Bit	4.4175	328
		Mono10/BayerRG10	CIS_10Bit	5.4680	406
		Mono8/BayerRG8	CIS_10Bit	4.4175	328

□Normal Speed Model I

Model	CXP Link Configuration		CIS Bit Size	Horizontal Period[usec] (default)	PARAM_H
BC-SMS24M10X1N BC-SCS24M10X1N	CXP3-1	Mono8/BayerRG8	CIS_8Bit	17.6969	1314
		Mono10/BayerRG10	CIS_10Bit	22.5723	1676
		Mono8/BayerRG8	CIS_10Bit	17.6969	1314
	CXP6-1	Mono8/BayerRG8	CIS_8Bit	8.8484	657
		Mono10/BayerRG10	CIS_10Bit	11.2862	838
		Mono8/BayerRG8	CIS_10Bit	8.8484	657
	CXP10-1	Mono8/BayerRG8	CIS_8Bit	6.0202	447
		Mono10/BayerRG10	CIS_10Bit	7.3939	549
		Mono8/BayerRG8	CIS_10Bit	7.3939	549
BC-SMS20M10X1N BC-SCS20M10X1N	CXP3-1	Mono8/BayerRG8	CIS_8Bit	15.0303	1116
		Mono10/BayerRG10	CIS_10Bit	18.3973	1366
		Mono8/BayerRG8	CIS_10Bit	15.0303	1116
	CXP6-1	Mono8/BayerRG8	CIS_8Bit	7.5151	558
		Mono10/BayerRG10	CIS_10Bit	9.2390	686
		Mono8/BayerRG8	CIS_10Bit	7.5151	558
	CXP10-1	Mono8/BayerRG8	CIS_8Bit	5.0505	375
		Mono10/BayerRG10	CIS_10Bit	6.3164	469
		Mono8/BayerRG8	CIS_10Bit	6.3164	469
BC-SMS16M10X1N BC-SCS16M10X1N	CXP3-1	Mono8/BayerRG8	CIS_8Bit	17.6969	1314
		Mono10/BayerRG10	CIS_10Bit	22.5723	1676
		Mono8/BayerRG8	CIS_10Bit	17.6969	1314
	CXP6-1	Mono8/BayerRG8	CIS_8Bit	8.8484	657
		Mono10/BayerRG10	CIS_10Bit	11.2862	838
		Mono8/BayerRG8	CIS_10Bit	8.8484	657
	CXP10-1	Mono8/BayerRG8	CIS_8Bit	6.0202	447
		Mono10/BayerRG10	CIS_10Bit	7.3939	549
		Mono8/BayerRG8	CIS_10Bit	7.3939	549

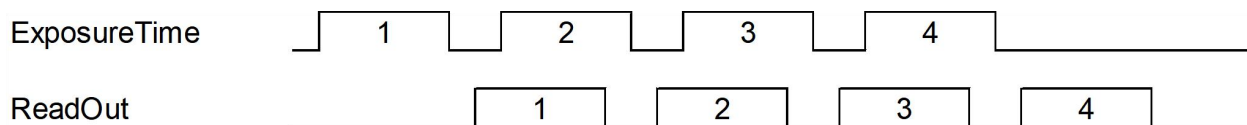
6.2.4 Trigger prohibition period when changing settings

Immediately after changing the 「Trigger Acquisition Mode」 or 「BinningVertical」 or 「ImageSensorBitSize」 or 「DecimationVertical」 or 「HorizontalPeriodExtend」, it takes time to change the mode inside the camera. Do not enter a trigger to camera during that period

Trigger input prohibition period : 2.5s

6.3 Exposure Mode

6.3.1 Exposure Mode : OFF(Free-Run)

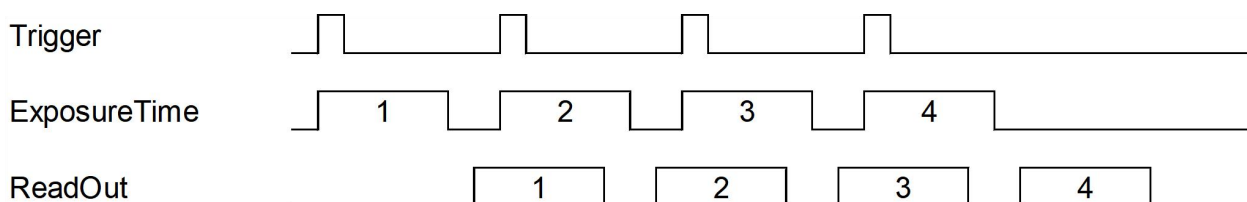


When this mode is set, camera outputs video image continuously.

The camera is exposed and outputs video image at the set [Acquisition framerate].

The exposure time is set to a maximum value within a preset [Acquisition framerate].

6.3.2 Exposure Mode : Timed



The camera is exposed within a preset [ExposureTime] and outputs video image from an external trigger.

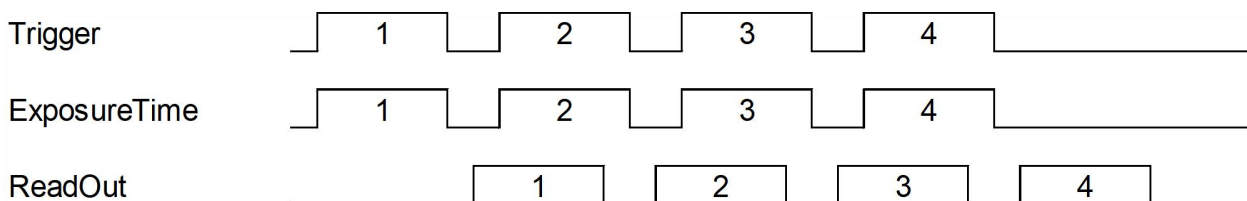
There is an upper limit to the timing at which a trigger can be input.

Refer to [Trigger prohibition time] and [FrameRate calculate].

When inputting a trigger from [LinkTrigger], the camera recognizes at the rising edge of the trigger signal.

When inputting a trigger from [Line*], user can select whether the trigger signal is recognized as a rising or a falling edge using the [LineInverter] setting.

6.3.3 Exposure Mode : Trigger Width



The camera is exposed for the same period as the external trigger and outputs the video image.

There is an upper limit to the timing at which a trigger can be input.

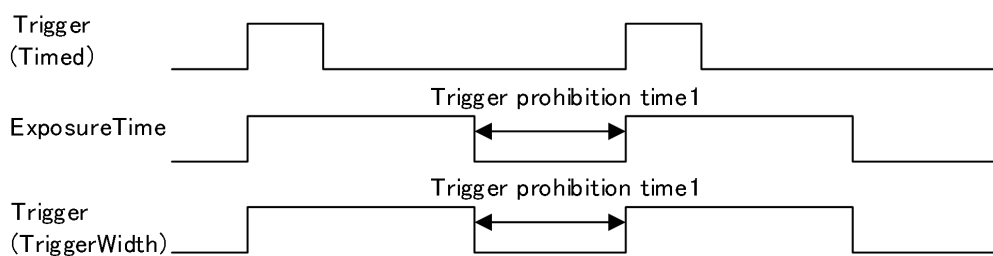
Refer to [Trigger prohibition time] and [FrameRate calculate].

6.3.4 Trigger prohibition Time

When inputting triggers with [Timed] or [TriggerWidth], there is a trigger prohibition time.
Do not enter the next trigger to camera during this period.

6.3.4.1 Trigger prohibition Time1

If you enter a trigger during this prohibition period, the trigger will be ignored inside the camera and the next trigger will be enabled.



The Trigger prohibition Time1 is shown in the following table.

Trigger Prohibition Time1 is calculated by the following formula.
 Trigger Prohibition Time1 = Horizontal Period x PARAM_V [sec]

□Trigger prohibition time1 (High Speed Model)

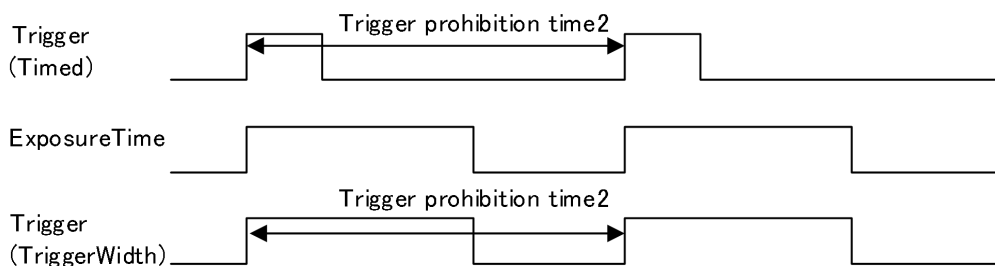
Model	CXP Link Configuration		CIS Bit Size	Trigger Prohibition Time1[usec] (default)	PARAM_V	
					Normal	Bining/Decimation
BC-SMS24M12X1H BC-SCS24M12X1H	CXP3-1	Mono8 / BayerRG8	CIS_8Bit	3256.242	184	214
		Mono10 / BayerRG10	CIS_10Bit	4153.319		
		Mono8 / BayerRG8	CIS_10Bit	3256.242		
	CXP6-1	Mono8 / BayerRG8	CIS_8Bit	1628.121		
		Mono10 / BayerRG10	CIS_10Bit	2076.660		
		Mono8 / BayerRG8	CIS_10Bit	1628.121		
	CXP10-1	Mono8 / BayerRG8	CIS_8Bit	1016.027		
		Mono10 / BayerRG10	CIS_10Bit	1253.925		
		Mono8 / BayerRG8	CIS_10Bit	1016.027		
	CXP12-1	Mono8 / BayerRG8	CIS_8Bit	812.821		
		Mono10 / BayerRG10	CIS_10Bit	1006.114		
		Mono8 / BayerRG8	CIS_10Bit	812.821		
BC-SMS20M12X1H BC-SCS20M12X1H	CXP3-1	Mono8 / BayerRG8	CIS_8Bit	2765.575	184	222
		Mono10 / BayerRG10	CIS_10Bit	3469.360		
		Mono8 / BayerRG8	CIS_10Bit	2765.575		
	CXP6-1	Mono8 / BayerRG8	CIS_8Bit	1382.787		
		Mono10 / BayerRG10	CIS_10Bit	1685.117		
		Mono8 / BayerRG8	CIS_10Bit	1382.787		
	CXP10-1	Mono8 / BayerRG8	CIS_8Bit	862.383		
		Mono10 / BayerRG10	CIS_10Bit	1253.925		
		Mono8 / BayerRG8	CIS_10Bit	862.383		
	CXP12-1	Mono8 / BayerRG8	CIS_8Bit	691.393		
		Mono10 / BayerRG10	CIS_10Bit	862.383		
		Mono8 / BayerRG8	CIS_10Bit	691.393		
BC-SMS16M12X1H BC-SCS16M12X1H	CXP3-1	Mono8 / BayerRG8	CIS_8Bit	3256.242	184	214
		Mono10 / BayerRG10	CIS_10Bit	4153.319		
		Mono8 / BayerRG8	CIS_10Bit	3256.242		
	CXP6-1	Mono8 / BayerRG8	CIS_8Bit	1628.121		
		Mono10 / BayerRG10	CIS_10Bit	2076.660		
		Mono8 / BayerRG8	CIS_10Bit	1628.121		
	CXP10-1	Mono8 / BayerRG8	CIS_8Bit	1016.027		
		Mono10 / BayerRG10	CIS_10Bit	1253.925		
		Mono8 / BayerRG8	CIS_10Bit	1016.027		
	CXP12-1	Mono8 / BayerRG8	CIS_8Bit	812.821		
		Mono10 / BayerRG10	CIS_10Bit	1006.114		
		Mono8 / BayerRG8	CIS_10Bit	812.821		

□ Trigger prohibition time1 (Normal Speed Model)

Model	CXP Link Configuration		CIS Bit Size	Trigger Prohibition Time1[usec] (default)	PARAM_V	
					Normal	Bining/Decimation
BC-SMS24M10X1N BC-SCS24M10X1N	CXP3-1	Mono8 / BayerRG8	CIS_8Bit	3256.242	184	214
		Mono10 / BayerRG10	CIS_10Bit	4153.319		
		Mono8 / BayerRG8	CIS_10Bit	3256.242		
	CXP6-1	Mono8 / BayerRG8	CIS_8Bit	1628.121		
		Mono10 / BayerRG10	CIS_10Bit	2076.660		
		Mono8 / BayerRG8	CIS_10Bit	1628.121		
	CXP10-1	Mono8 / BayerRG8	CIS_8Bit	1107.717		
		Mono10 / BayerRG10	CIS_10Bit	1360.484		
		Mono8 / BayerRG8	CIS_10Bit	1107.717		
BC-SMS20M10X1N BC-SCS20M10X1N	CXP3-1	Mono8 / BayerRG8	CIS_8Bit	2014.060	184	222
		Mono10 / BayerRG10	CIS_10Bit	3143.056		
		Mono8 / BayerRG8	CIS_10Bit	2014.060		
	CXP6-1	Mono8 / BayerRG8	CIS_8Bit	1007.030		
		Mono10 / BayerRG10	CIS_10Bit	1283.151		
		Mono8 / BayerRG8	CIS_10Bit	1007.030		
	CXP10-1	Mono8 / BayerRG8	CIS_8Bit	676.767		
		Mono10 / BayerRG10	CIS_10Bit	846.410		
		Mono8 / BayerRG8	CIS_10Bit	846.410		
BC-SMS16M10X1N BC-SCS16M10X1N	CXP3-1	Mono8 / BayerRG8	CIS_8Bit	2265.212	184	214
		Mono10 / BayerRG10	CIS_10Bit	2889.265		
		Mono8 / BayerRG8	CIS_10Bit	2265.212		
	CXP6-1	Mono8 / BayerRG8	CIS_8Bit	1132.606		
		Mono10 / BayerRG10	CIS_10Bit	1444.633		
		Mono8 / BayerRG8	CIS_10Bit	1132.606		
	CXP10-1	Mono8 / BayerRG8	CIS_8Bit	770.585		
		Mono10 / BayerRG10	CIS_10Bit	946.424		
		Mono8 / BayerRG8	CIS_10Bit	946.424		

6.2.1.1 Trigger prohibition Time2

If you enter a trigger during this prohibition period, the trigger will be ignored inside the camera and the next trigger will take effect.



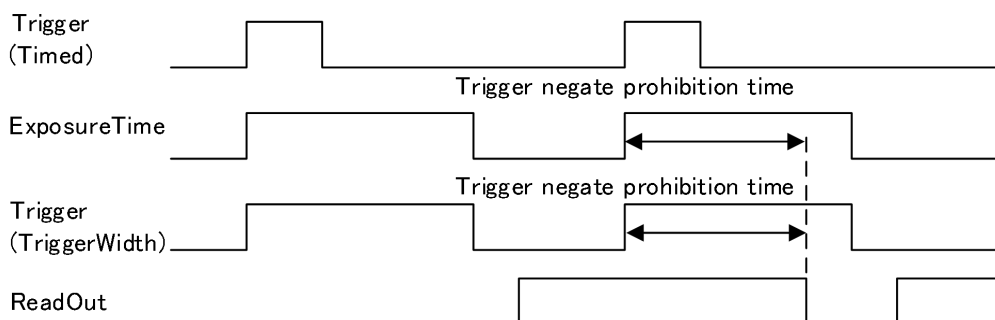
$$\text{Trigger prohibition Time2} = 1/(\text{Acquisition framerate setting value})$$

6.2.1.2 Trigger negate prohibition Time

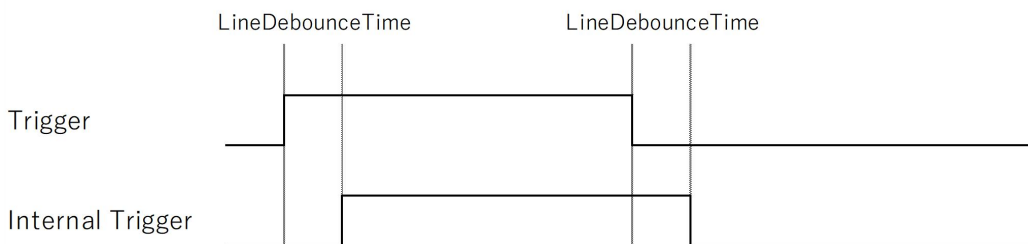
Do not disable the trigger during image output. If disabled, it will be as follows depending on the mode.

「Timed」 : The trigger input that meets this condition is disabled inside the camera, and the next trigger is enabled.

「TriggerWidth」 : The camera image becomes abnormal, and in the worst case, it is necessary to turn off / on the power of the camera.



6.3.5 Trigger LineDebounce Time



Generates an internal trigger after the time set in LineDebounceTime elapses after the trigger is detected. LineDebounceTime is added to the internal trigger. It can be used as a trigger signal filtering function.

6.3.6 Minimum ExposureTime

There is a lower limit (Minimum Exposure Time) for the Exposure Time that can be set. It depends on the operation mode as shown in the table below.

□Minimum ExposureTime (High Speed Model)

Model	CXP Link Configuration		CIS Bit Size	Minimum Exposure Time [usec]	
				Overlap Mode	Fast Trigger Mode
BC-SMS24M12X1H BC-SCS24M12X1H	CXP3-1	Mono8 / BayerRG8	CIS_8Bit	21	145
		Mono10 / BayerRG10	CIS_10Bit	26	184
		Mono8 / BayerRG8	CIS_10Bit	21	145
	CXP6-1	Mono8 / BayerRG8	CIS_8Bit	12	74
		Mono10 / BayerRG10	CIS_10Bit	14	93
		Mono8 / BayerRG8	CIS_10Bit	12	74
	CXP10-1	Mono8 / BayerRG8	CIS_8Bit	8	47
		Mono10 / BayerRG10	CIS_10Bit	10	57
		Mono8 / BayerRG8	CIS_10Bit	8	47
	CXP12-1	Mono8 / BayerRG8	CIS_8Bit	7	38
		Mono10 / BayerRG10	CIS_10Bit	8	47
		Mono8 / BayerRG8	CIS_10Bit	7	38
BC-SMS20M12X1H BC-SCS20M12X1H	CXP3-1	Mono8 / BayerRG8	CIS_8Bit	18	183
		Mono10 / BayerRG10	CIS_10Bit	21	150
		Mono8 / BayerRG8	CIS_10Bit	18	123
	CXP6-1	Mono8 / BayerRG8	CIS_8Bit	10	93
		Mono10 / BayerRG10	CIS_10Bit	12	77
		Mono8 / BayerRG8	CIS_10Bit	10	63
	CXP10-1	Mono8 / BayerRG8	CIS_8Bit	8	59
		Mono10 / BayerRG10	CIS_10Bit	12	50
		Mono8 / BayerRG8	CIS_10Bit	8	40
	CXP12-1	Mono8 / BayerRG8	CIS_8Bit	7	48
		Mono10 / BayerRG10	CIS_10Bit	9	40
		Mono8 / BayerRG8	CIS_10Bit	7	33
BC-SMS16M12X1H BC-SCS16M12X1H	CXP3-1	Mono8 / BayerRG8	CIS_8Bit	21	145
		Mono10 / BayerRG10	CIS_10Bit	26	184
		Mono8 / BayerRG8	CIS_10Bit	21	145
	CXP6-1	Mono8 / BayerRG8	CIS_8Bit	12	74
		Mono10 / BayerRG10	CIS_10Bit	14	93
		Mono8 / BayerRG8	CIS_10Bit	12	74
	CXP10-1	Mono8 / BayerRG8	CIS_8Bit	8	47
		Mono10 / BayerRG10	CIS_10Bit	10	57
		Mono8 / BayerRG8	CIS_10Bit	8	47
	CXP12-1	Mono8 / BayerRG8	CIS_8Bit	7	38
		Mono10 / BayerRG10	CIS_10Bit	8	47
		Mono8 / BayerRG8	CIS_10Bit	7	38

□Minimum ExposureTime (Normal Speed Model)

Model	CXP Link Configuration		CIS Bit Size	Minimum Exposure Time [usec]	
				Overlap Mode	Fast Trigger Mode
BC-SMS24M10X1N BC-SCS24M10X1N	CXP3-1	Mono8 / BayerRG8	CIS_8Bit	21	74
		Mono10 / BayerRG10	CIS_10Bit	26	93
		Mono8 / BayerRG8	CIS_10Bit	21	74
	CXP6-1	Mono8 / BayerRG8	CIS_8Bit	12	38
		Mono10 / BayerRG10	CIS_10Bit	14	48
		Mono8 / BayerRG8	CIS_10Bit	12	38
	CXP10-1	Mono8 / BayerRG8	CIS_8Bit	9	27
		Mono10 / BayerRG10	CIS_10Bit	10	33
		Mono8 / BayerRG8	CIS_10Bit	10	33
BC-SMS20M10X1N BC-SCS20M10X1N	CXP3-1	Mono8 / BayerRG8	CIS_8Bit	18	93
		Mono10 / BayerRG10	CIS_10Bit	21	77
		Mono8 / BayerRG8	CIS_10Bit	18	63
	CXP6-1	Mono8 / BayerRG8	CIS_8Bit	10	33
		Mono10 / BayerRG10	CIS_10Bit	12	40
		Mono8 / BayerRG8	CIS_10Bit	10	33
	CXP10-1	Mono8 / BayerRG8	CIS_8Bit	8	23
		Mono10 / BayerRG10	CIS_10Bit	9	28
		Mono8 / BayerRG8	CIS_10Bit	9	28
BC-SMS16M10X1N BC-SCS16M10X1N	CXP3-1	Mono8 / BayerRG8	CIS_8Bit	21	74
		Mono10 / BayerRG10	CIS_10Bit	26	93
		Mono8 / BayerRG8	CIS_10Bit	21	74
	CXP6-1	Mono8 / BayerRG8	CIS_8Bit	12	38
		Mono10 / BayerRG10	CIS_10Bit	14	48
		Mono8 / BayerRG8	CIS_10Bit	12	38
	CXP10-1	Mono8 / BayerRG8	CIS_8Bit	9	27
		Mono10 / BayerRG10	CIS_10Bit	10	33
		Mono8 / BayerRG8	CIS_10Bit	10	33

7 FrameRate calculate [Frame Rate calculation]

 High Speed Model

Model	Frame rate calculation formula
BC-SMS24M12X1H BC-SCS24M12X1H	$1 / \text{Horizontal Period} / (\text{Height} + \text{PARAM_V})$ [fps] (Height = 4608 / 2 for Decimation)
BC-SMS20M12X1H BC-SCS20M12X1H	$1 / \text{Horizontal Period} / (\text{Height} + \text{PARAM_V})$ [fps] (Height = 4512 / 2 for Decimation)
BC-SMS16M12X1H BC-SCS16M12X1H	$1 / \text{Horizontal Period} / (\text{Height} + \text{PARAM_V})$ [fps] (Height = 3040 / 2 for Decimation)

 Normal Speed Model

Model	Frame rate calculation formula
BC-SMS24M10X1N BC-SCS24M10X1N	$1 / \text{Horizontal Period} / (\text{Height} + \text{PARAM_V})$ [fps] (Height = 4608 / 2 for Decimation)
BC-SMS20M10X1N BC-SCS20M10X1N	$1 / \text{Horizontal Period} / (\text{Height} + \text{PARAM_V})$ [fps] (Height = 4512 / 2 for Decimation)
BC-SMS16M10X1N BC-SCS16M10X1N	$1 / \text{Horizontal Period} / (\text{Height} + \text{PARAM_V})$ [fps] (Height = 3040 / 2 for Decimation)

Round down to the second decimal place.

※The Horizontal Period depends on the camera settings.

6.2.3 Refer to [Horizontal Period by camera settings].

※Calculate with the following formula for both monochrome / color models when setting Decimation,
Height = SensorHeight / 2

8 Revision Information

Rev	Date	Changes
0.0	2022/8/8	Released